



# **MODULAR SOLUTIONS FOR ELECTRIC VEHICLE CHARGING STATIONS & RENEWABLE ENERGY PRODUCTION**

**RON SINGH, EMEA SALES DIR. – DIGI INTL**

# ELECTRIC VEHICLE CHARGING STATION MARKET: MARKET DYNAMICS



Rising EV Sales Worldwide  
Govt Policies & Subsidies  
Increased Global Awareness & Concern of Environmental Pollution  
Increasing Vehicle Range Between Charges



Lack Of Standardisation In Charging Infrastructure  
Primitive Power Grid Infrastructure (Renewables vs Fossil Fuels)



**OPPORTUNITIES**

Use of Vehicle-To-Grid EV Charging Stations  
EV Charging Stations Powered By Renewable Sources



High Initial Costs Of EV's vs ICE Vehicles  
Stringent Rules For EV Charging Station Installation

# EV CHARGING INFRASTRUCTURE FORECAST



**Domestic  
Charging Is  
Preferred Mode**



**Global  
Deployment @  
66M units by 2030**



**Europe Home  
Deployments @ 20M  
households by 2030**

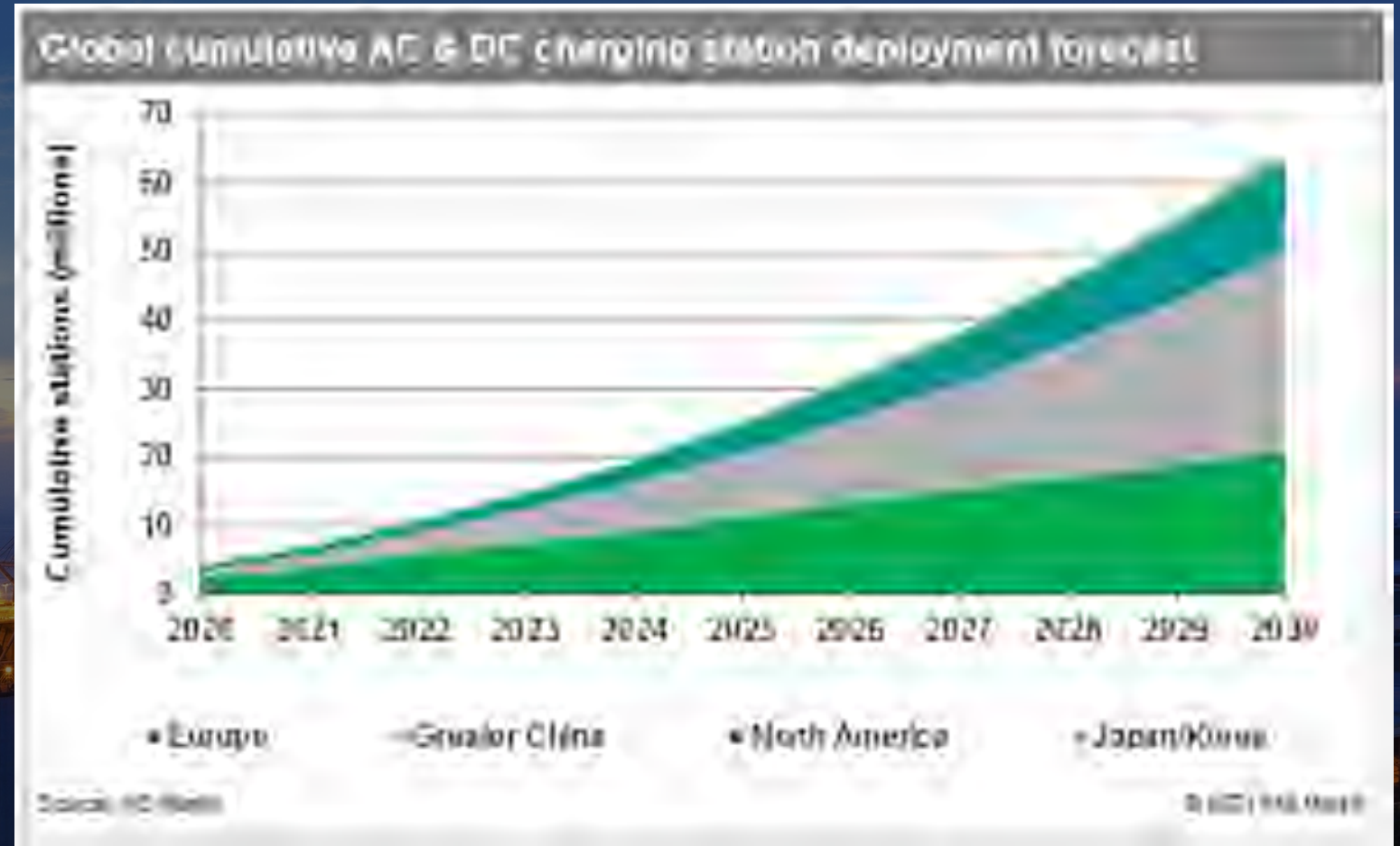

# RUGBY (UK) MOTO SERVICES



# MARKET TOUCHPOINTS

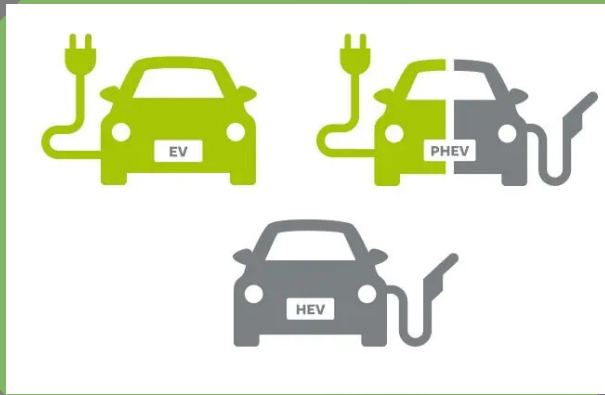

**VEHICLE TYPE  
SEGMENTATION**

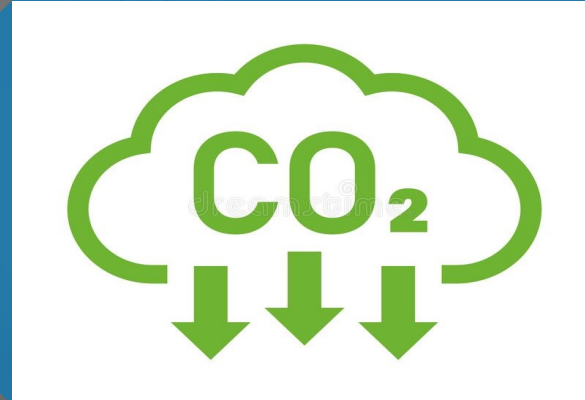

**REDUCING CO<sub>2</sub>  
EMISSIONS GOALS**



**END USER  
MIGRATION**

# EV CHARGER TYPES

Public charger

7.4–22  
kW

Time to add 32 km:

15  
minutes



EV CHARGING<sup>®</sup>  
THE POWER OF THREE

Ultra fast charger

175  
kW

Time to add 32 km:

3  
minutes



EV CHARGING<sup>®</sup>  
THE POWER OF THREE

HPC

Up to  
350  
kW

Time to add 32 km:

1  
minutes



EV CHARGING<sup>®</sup>  
THE POWER OF THREE

First fast charger  
infrastructure

50  
kW

Time to add 32 km:

7  
minutes



EV CHARGING<sup>®</sup>  
THE POWER OF THREE

Domestic charger

3.7–7.4  
kW

Time to add 32 km:

91  
minutes



EV CHARGING<sup>®</sup>  
THE POWER OF THREE

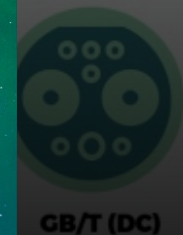

# CONSTRAINTS

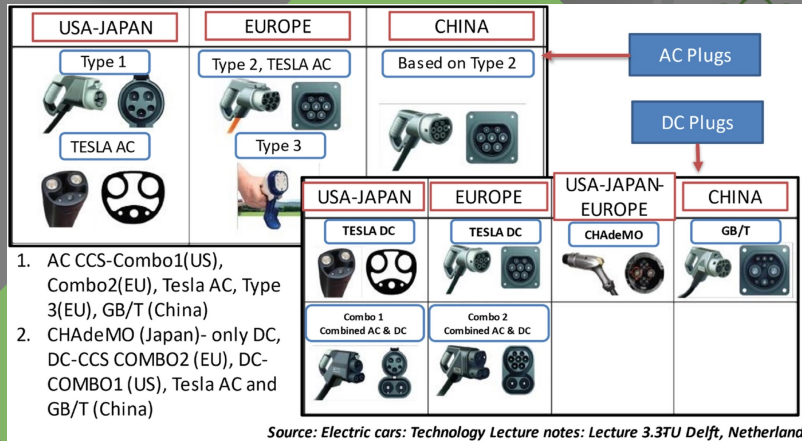

**LACK OF CHARGING STANDARDISATION**

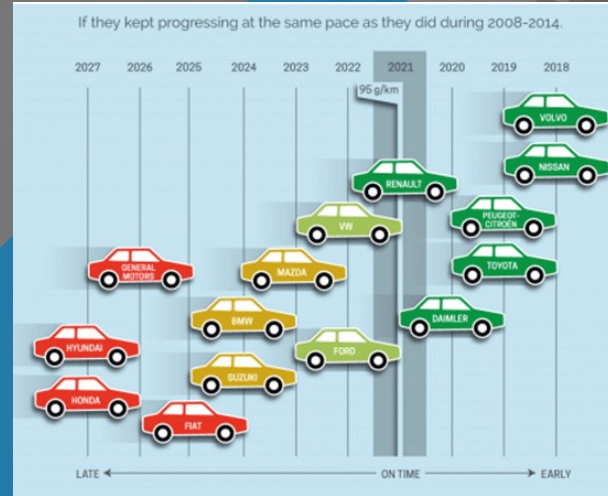

**NEED FOR LONGER RANGE EV'S**



**CHARGING CAPACITY SUPPLY**

# CHARGING STATION TYPES

## Simple E-Car Charger

Charger connected to the home power network  
Box with power converter & fuses for simple plug and charge  
Current charge status visible only at car  
No possibility of self-charge management during the cheapest electricity time (some contracts use the different price at different daytime – cheaper at night)

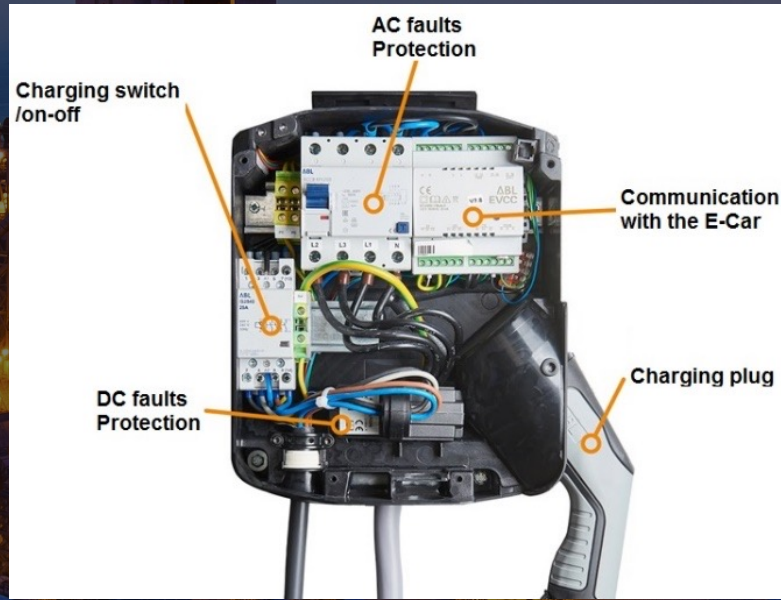

## Intelligent E-Car Charger

Charger box which can be connected to public / company power networks  
Possible GSM connection to a central control or smart-phone  
Possible Wi-Fi connectivity to residential network  
Intelligent charging management: time, source (e.g. solar power) etc.  
RFID reader or NFC credit-card payment terminal

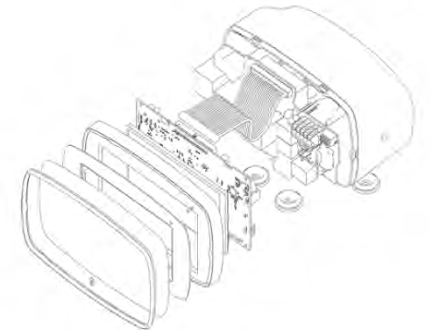



# INTELLIGENT E-CAR CHARGING STATION

High Resolution Display

Credit-Card Payment  
Terminal

RFID Reader

Connectivity: GSM,  
Wi-Fi, BT

Charging Process  
Management S/W

Environmental  
Conditions Sensors



# INTELLIGENT E-CAR CHARGING STATION



LCD Interface



UART/ SPI/ LAN for Payment Terminal



UART/USB/SPI

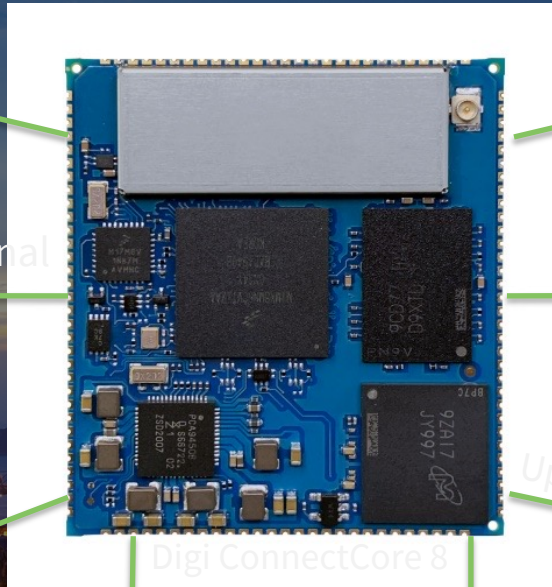

Digi ConnectCore 8

CAN Interface

Secure Element

DIGI Yocto /Android: Cellular Support



Pre-certified WLAN 802.11a/b/g/n/ac & Bluetooth 5.0



Up to 4x Cortex®-A53 Cores @ 1.4 GHz



# INTELLIGENT E-CAR CHARGING STATION



LVDS & 24bit LCD Interface



LAN /USB

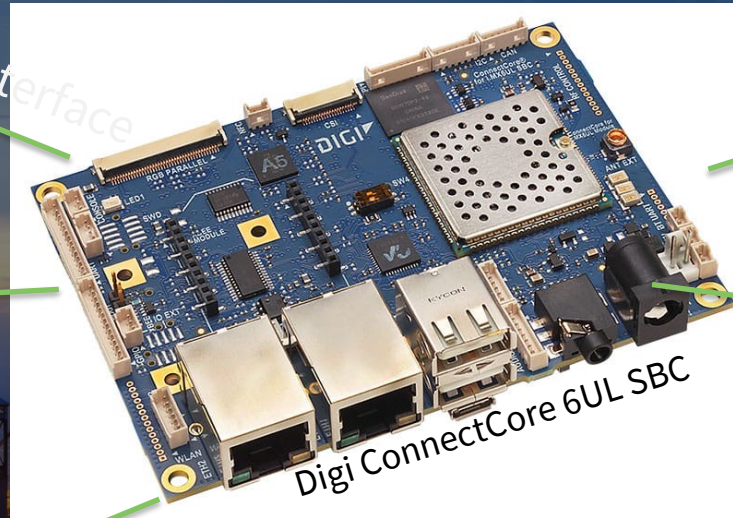

Digi ConnectCore 6UL SBC

DIGI Yocto /Android: Cellular  
Support PCI-Express Slot

NXP i.MX6UL-2, Cortex-A7  
@ 528 MHz

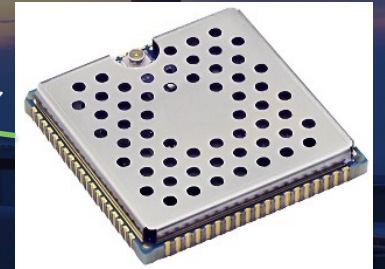

Pre-certified 802.11a/b/g/n/ac  
& Bluetooth® 5



USB RFID Reader

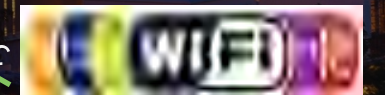

# INTELLIGENT E-CAR CHARGING STATION

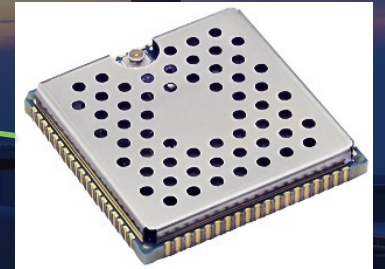
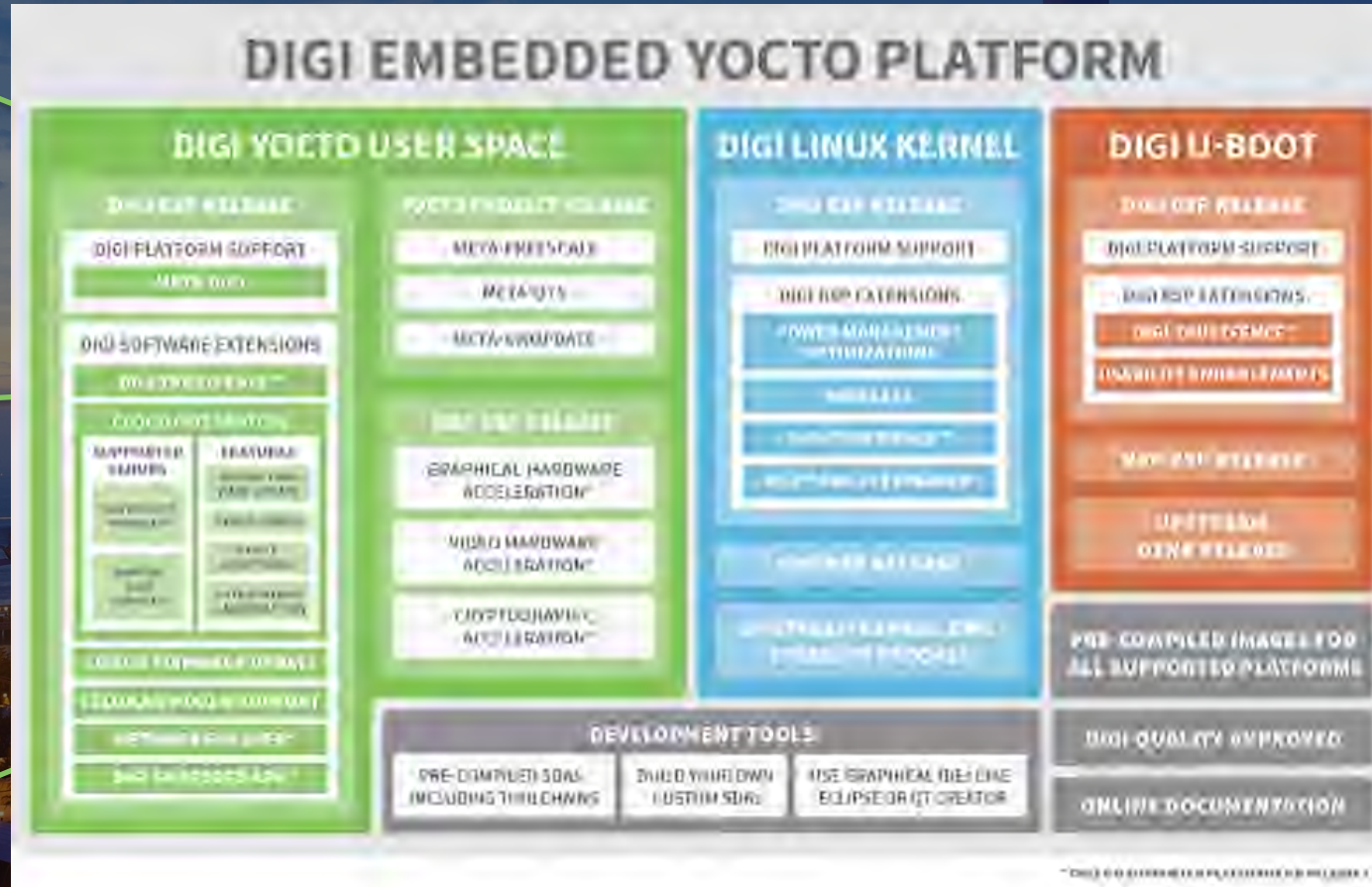
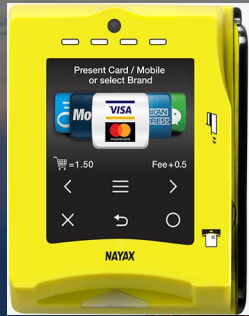

# INTELLIGENT E-CAR CHARGING STATION



NB-IoT/ LTE-M  
Connectivity

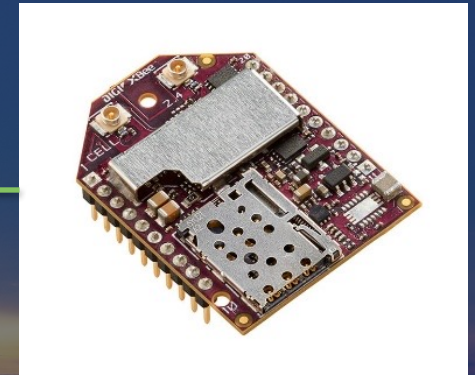

LTE Remote Access &  
Management Connectivity

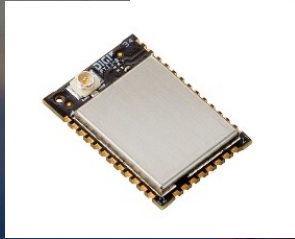

Digi XBee® 3  
DigiMesh®, Zigbee, 802.15.4

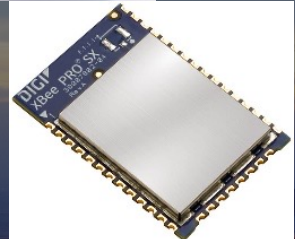

Digi Xbee LR  
868 MHz, 900 MHz



Digi Xbee Gateway  
ZigBee to LAN or Cellular  
Connectivity

# TRACKING SOLUTIONS FOR SOLAR PANEL FARMS



Digi XBee® 3  
DigiMesh®, Zigbee, 802.15.4

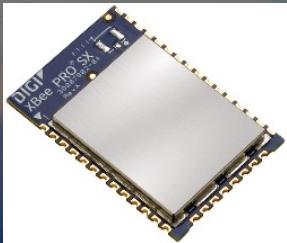

Digi Xbee LR  
868 MHz, 900 MHz



Digi Xbee Gateway  
ZigBee to LAN or Cellular  
Connectivity



# FASTER-TIME-TO-MARKET: SELECTING MODULAR OVER COMPONENT DESIGN



OPPORTUNITY  
COST



TIMING  
ADVANTAGE



TECNOLOGY  
DEBT



ON-TIME NPI



MODULAR  
DESIGN  
NAIVETY

# FASTER-TIME-TO-MARKET: CORE COMPETENCIES REQUIRED FOR CHIP-DOWN DESIGN



SOFTWARE  
DEVELOPMENT



TIME-TO-MARKET /  
OPPY COST



HARDWARE  
DEVELOPMENT



MANUFACTURING



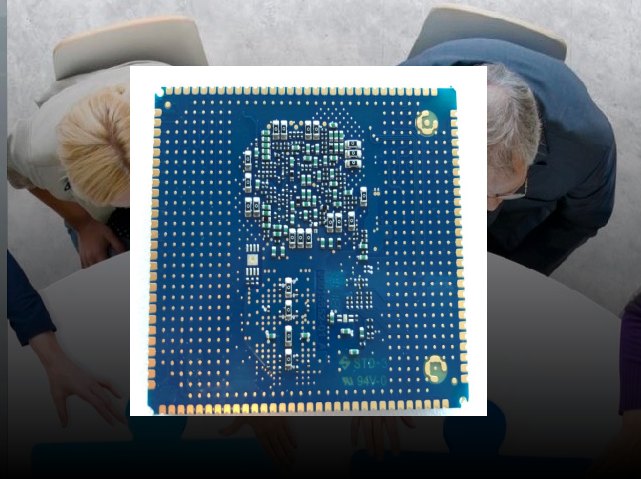
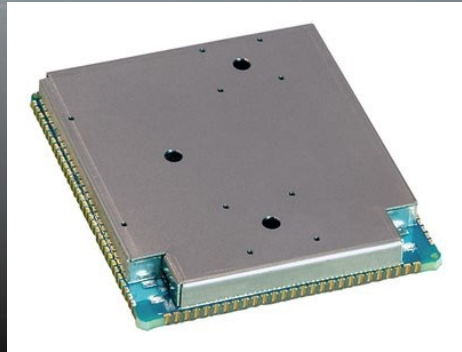

# BUILD VS BUY: IT'S SHEER COMPONENT COUNT!

## CORE

Main MPU  
Security Element  
Administrator MCU  
Memories & Radios

## ANCILLARY

PMIC & Power  
Filters, Multiplexers  
& Signal Chain  
Diodes, Crystals /  
Clocks & Passives

## COUNT

An i.MX6UL-based SOM = 230 comps  
An iMX.8X-based SOM = 440 components

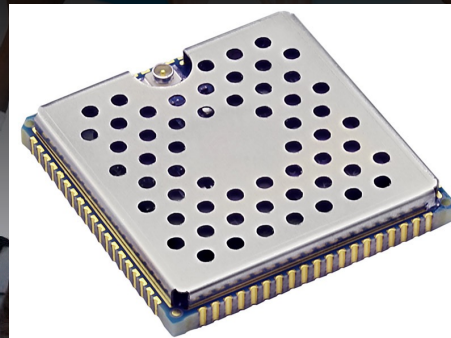

# BEAT YOUR COMPETITION: TIME SAVINGS ADD UP



**Hardware &  
Software  
Definition**



**Save\$ & Simplify  
PCB Design for  
Manufacture**



**Time to Market,  
Development  
Cost, Risk**

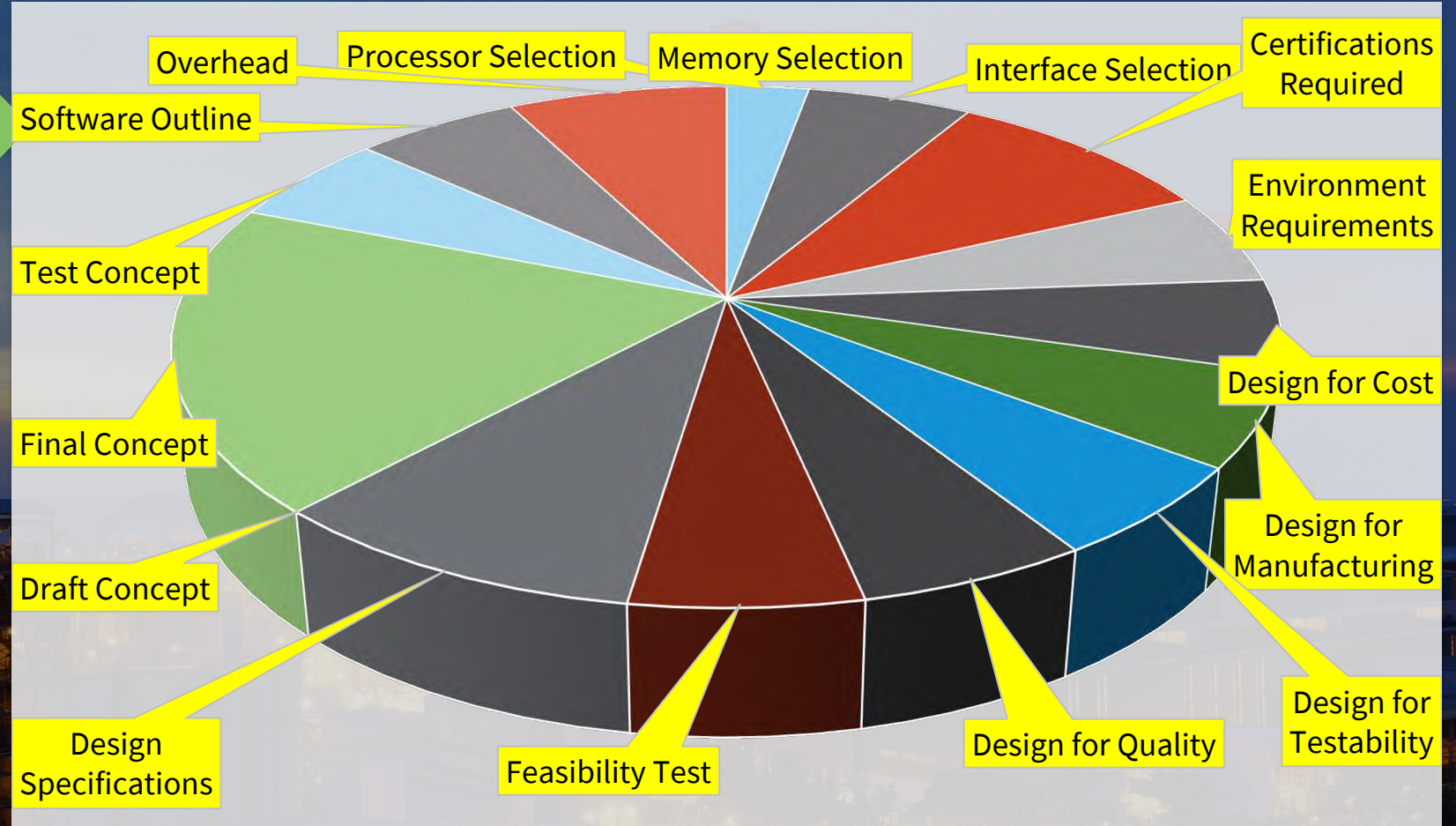

# BEAT YOUR COMPETITION: TIME SAVINGS ADD UP



**Hardware &  
Software  
Definition**



**Save\$ & Simplify  
PCB Design for  
Manufacture**



**Time to Market,  
Development  
Cost, Risk**

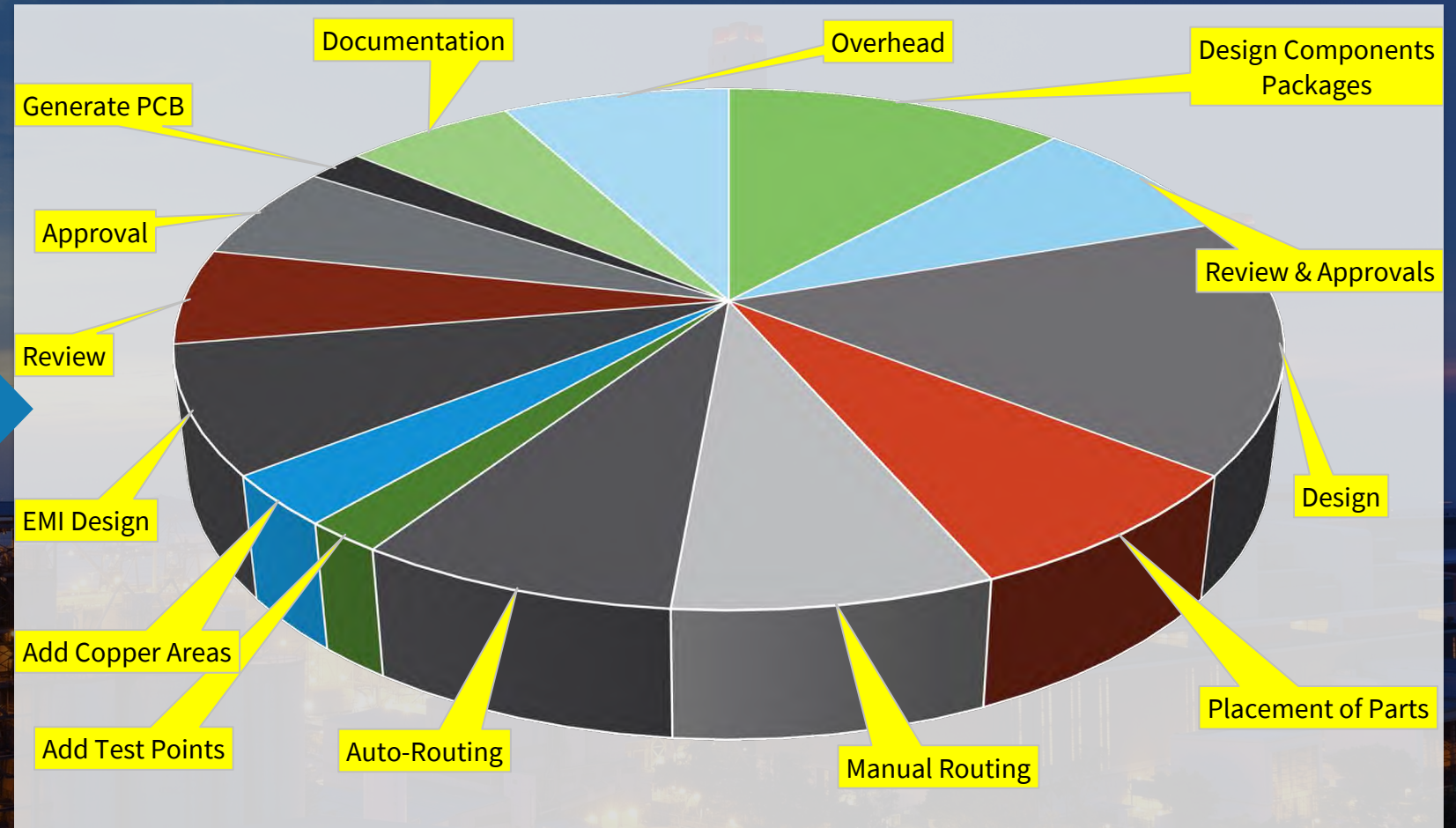

# BEAT YOUR COMPETITION: TIME SAVINGS ADD UP



Hardware &  
Software  
Definition



Save\$ & Simplify  
PCB Design for  
Manufacture



Time to Market,  
Development  
Cost, Risk

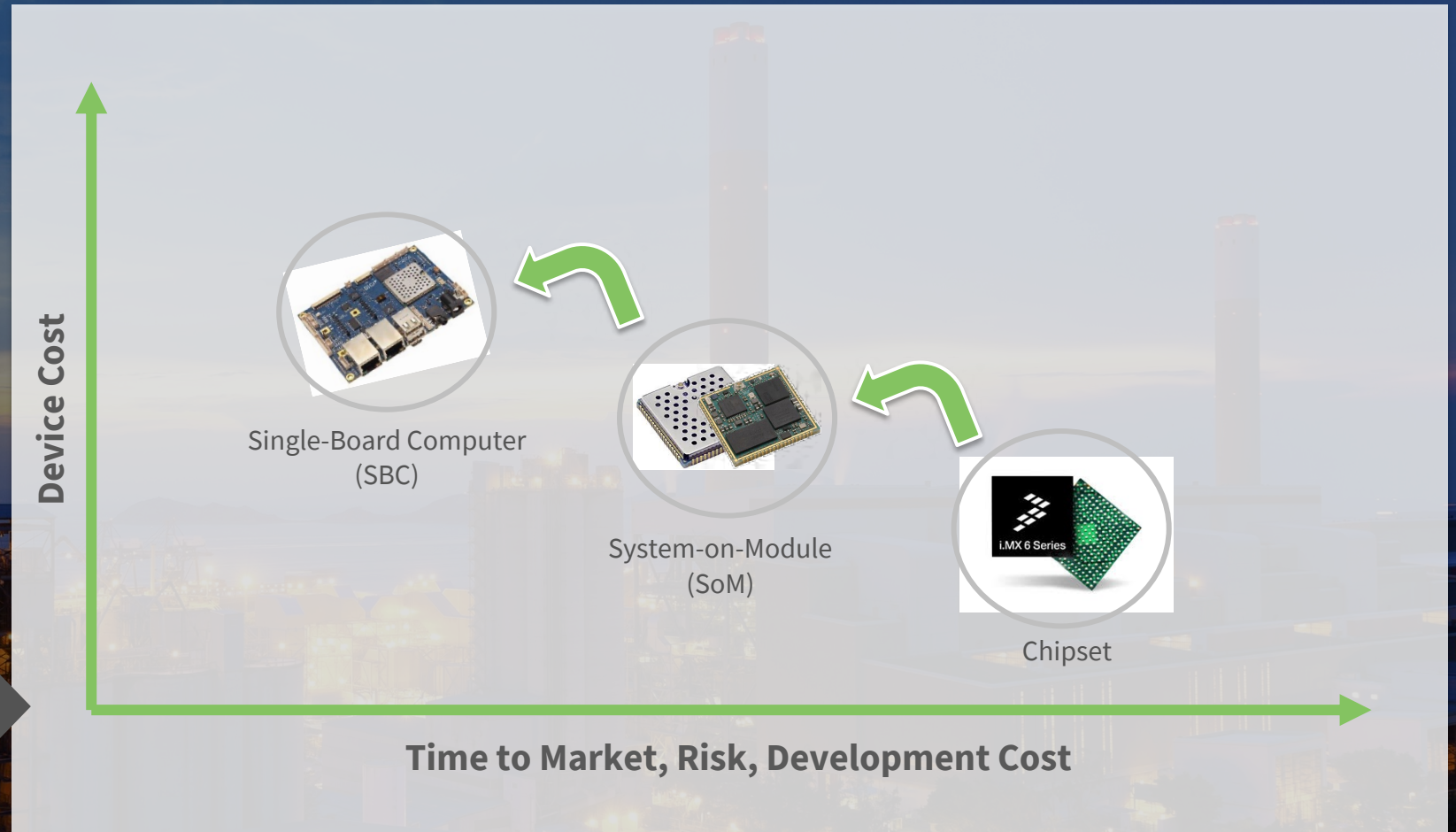

# BEAT YOUR COMPETITION: SOFTWARE TIME SAVINGS

- Module BSP = Comprehensive S/W Driver Libraries
- Module BSP = Validated ✓
- Application S/W Creation @ Day One = Parallel Engineering Development
- Performance Testing

# **FASTER-TIME-TO-MARKET: WIRELESS APPROVALS & CERTIFICATIONS**



## **CAN YOU AMORTISE THE COST ACROSS YOUR VOLUME?**

- FCC/ETSI/RED Approvals = \$50K to \$100K
- Bluetooth SIG = \$20K to \$30K

# FASTER-TIME-TO-MARKET: WIRELESS APPROVALS & CERTIFICATIONS



## CAN YOU AMORTISE THE COST ACROSS YOUR VOLUME?

- FCC/ETSI/RED Approvals = \$50K to \$100K
- Bluetooth SIG = \$20K to \$30K

Type of Design	Certification	Approx. Cost	Time (weeks)
ATT-certified Cellular module	Cellular and FCC Unintentional Radiator	@\$25K	8
	Bluetooth FCC and SIG	@\$10K	10
	Europe RED	@\$15K	8
Module design w/BTLE	USA EU Canada combined	@\$35K	16
Hi Power sub-GHz Module	USA and Canada	@\$10K	8
Single radio sub-GHz Module	Europe	@\$15K	8

# MAINTAIN YOUR LEAD: RISK MINIMIZATION



**UPGRADEABILITY =  
STAYING RELEVANT**



**MODULAR  
FLEXIBILITY**



**REDUCING RISK  
= TIME & COST**



# MAINTAIN YOUR LEAD: INTEREST ON INVESTMENTS



**Economies of Scale**



**Consolidating Your Demand**



**Equipment Cost & Maintenance**



# MODULE IOT DEVICE SECURITY

*There is a cost consideration for the implementation AND maintenance of a security platform for your product and potential liabilities that you cannot ignore!*

## ARE YOU CONCERNED ABOUT CONNECTED DEVICE SECURITY?

70%

of IoT devices are vulnerable to attack.

Source: HP Security Research



# DIGI'S MODULAR OFFERING

To **simplify** and **accelerate** the development, deployment and management of secure, connected products so customers can **save time, money, risk** and **focus on their core competency** instead of embedded wireless design complexity

## ConnectCore<sup>®</sup>

arm



Intelligent, Secure, Connected  
System-on-Modules



## XBee<sup>®</sup>

Cat-1  
LTE-M  
NB-IoT

Bluetooth

zigbee

IEEE  
802.15.4



868 MHz

DigiMesh

WiFi

900 MHz

Simple, Flexible, Secure  
Wireless Connectivity

# DIGI ConnectCore® IS HARDWARE-ENABLED, SOFTWARE-DEFINED

## CLOUD INTEGRATION



## DEVICE MANAGEMENT



## CONNECTIVITY



## SOFTWARE & TOOLS



## EMBEDDED SOMs



## SUPPORT & DESIGN SERVICES



# ConnectCore® THE MOST COMPLETE, HIGHLY INTEGRATED NXP I.MX-BASED SOMS FOR INDUSTRIAL & MEDICAL APPLICATIONS

Scalable

Integrated

Complete SW

Connected

Secure

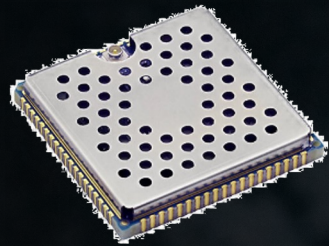

Industrial Grade  
10+ Year Longevity

# DIGI ConnectCore® PORTFOLIO



 **ConnectCore® MP133**  
STM32MP133C  
1 x Cortex-A7 @ 650MHz  
128 MB – 1 GB Flash (NAND)  
128 MB – 1GB RAM (DDR3L)  
2xGbE, Camera, no LCD

**In Development**

 **ConnectCore® 6UL**  
NXP i.MX6UL  
Cortex-A7 @ 528 MHz  
256 MB – 1 GB Flash (NAND)  
256 MB – 1 GB RAM (DDR3)  
Display/Camera

**In Production**

 **ConnectCore® MP157**  
STM32MP157C Dual  
2 x Cortex-A7 @ 650MHz + M4  
256 MB - 1 GB Flash (NAND)  
256 MB - 1 GB RAM (DDR3L)  
1xGbE, GPU, Display/Camera

**In Development**

 **ConnectCore® 6N/6+**  
NXP i.MX6 Dual/Quad  
2-4 x Cortex-A9 @ up to 1GHz  
Up to 8 GB Flash (NAND)  
Up to 2 GB RAM (DDR3)  
HD GPU/VPU,  
Multi-Display/Camera

**NRND**

 **ConnectCore® 8M Nano**  
NXP i.MX8M Nano Solo/Quad  
1-4 x Cortex-A53 @ 1.4 GHz  
Up to 8 GB Flash (eMMC)  
Up to 1 GB RAM (LPDDR4)  
HD GPU  
Display/Camera

**In Production**

 **ConnectCore® 8M Mini**  
NXP i.MX8M Mini Quad  
4 x Cortex-A53 @ 1.6 GHz  
Up to 8 GB Flash (eMMC)  
Up to 2 GB RAM (LPDDR4)  
HD GPU/VPU  
Display/Camera

**In Production**

 **ConnectCore® 8X**  
NXP i.MX8X Dual/Quad  
2-4 x Cortex-A35 @ 1.2 GHz  
Up to 16 GB Flash (eMMC)  
Up to 2 GB RAM (LPDDR4)  
HD GPU/VPU  
Multi-Display/Camera

**In Production**



# THE MOST COMPLETE, EASIEST TO USE WIRELESS NETWORKING SOLUTION FOR IOT

Simple

Flexible

Secure

Future Proof

Cat-1 LTE-M NB-IoT

Bluetooth

zigbee

IEEE 802.15.4

OVER 15 MILLION DEPLOYED

868 MHZ

DigiMesh

WiFi

900 MHZ



Pin Compatible



Global Certifications

# XBEE® IS A COMPLETE IOT NETWORKING SOLUTION



Cloud

**DIGI**  
REMOTE MANAGER  
Device Management

**AWS** **Microsoft Azure** **Private Cloud**  
Cloud Integration



Cellular  
Ethernet  
Wi-Fi

Gateways

**at&t**  
**verizon**  
**Deutsche Telekom**  
**vodafone**  
+ Global Operators

**Data Plans**  
**Requirements**  
**SW / FW**  
**HW / RF / Certs**

Modules

**zigbee** **Bluetooth**  
**DigiMesh®** + **802.15.4**  
Short Range (2.4 GHz)

**DigiMesh®** **Star/P2P**  
**XBee3 Long Range (868 MHz)**

**lteCat-1**  
**LTE-M**  
**NB-IoT**  
Cellular

Software and Tools

**XCTU** **XBee APIs** **XBee Libraries (C, Java, Python)** **Edge Compute** **PyCharm IDE Plug-In** **Network Assistant** **XBee Mobile App & SDK** **Multi Programmer** **Interface Boards** **GPS Daughter Board** **Security**

Professional Services



# THE INTERNET OF GETTING THINGS DONE

Solving **MISSION-CRITICAL** and  
**BUSINESS-CRITICAL** machine communications  
challenges in the most **DEMANDING ENVIRONMENTS**.

You get proven, no-nonsense  
**SOLUTIONS THAT WORK** — and keep working.

**DIGI**  Connect with Confidence



RELIABILITY



SCALABILITY



SECURITY



MANAGEABILITY